

**High voltage supply EHV 110 A for ESQ electron beam guns**

A product of BALZERS AG, Balzers

Issued: July 1980 / DN 9223

**DANGER HIGH VOLTAGE**

Touching parts under high voltage is absolutely **FATAL**.

Service work on the high voltage supply and the high voltage feedthroughs may only be carried out by qualified personnel. Service work on the high voltage system may only be carried out when the high voltage has been turned off.

The system is considered turned off when the master switch (MAIN SWITCH) on the EHV 110 A has been turned off or when the mains plug has been disconnected.

As a safety precaution a screw coupling connection is to be made from the grounding bar in the high voltage supply to the high voltage output (capacitor discharge).

The various terminals in the interlock circuit must not be considered as safety elements.

Caution:

When the cabinet doors are open and the high voltage supply is on there is **FATAL DANGER**.

The cabinet door of the EHV 110 A is only to be opened with a specially marked key (high voltage lightning streak). This key may only be carried by a qualified electrical expert.

The doors to the system frame must be provided with a lock. For service purposes the doors to the system frame may only be opened by a qualified electrical expert. Interlock switches on the frame doors do not qualify as safety elements. Before installing the EHS, therefore, be sure that the master switch is off or that the mains plug has been pulled.

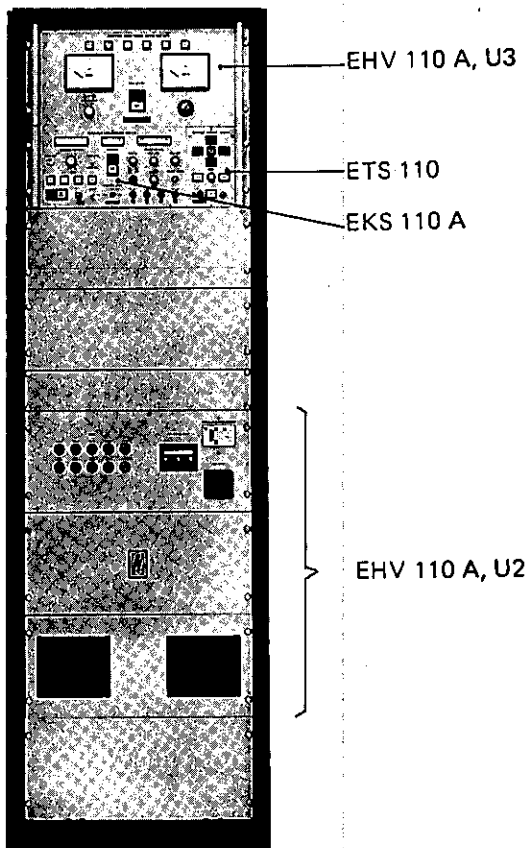
**1. DESCRIPTION**

The modular design of the power supply enables two or three evaporation sources to be operated independently, in one or more vacuum coating plants (vacuum chambers).

The entire power supply system (except the EHS) is contained in a rack cabinet. This cabinet houses the high voltage section, comprising high voltage transformer, control triode, rectifier, etc., which are permanently mounted in the lower section. The control unit U 3 is located in the top of the rack cabinet. Below, there are the gun control units EKS (No. 1, 2 and 3) and the crucible control units ETS.

A reciprocal influence of the individual sources is effective only to the extent that the total output power of the high voltage supply (electron beam power) is limited to 15 kW. One important difference in multi-gun operation is, that the work can be carried out either in one or more evaporation chambers. If the evaporation is to take place in one chamber only, the high voltage circuit for all the evaporation sources will be connected in parallel. The corresponding interlock circuit (vacuum, stand doors, auxil.) is the same for all guns and is effective through the relay of the high voltage transformer interlock circuit 1).

When the vacuum chamber or a cabinet door (EHV 110 A) is opened, the circuit breaker (F9) switches off. This second interlock circuit is effective only if the contactor 2K2 has not been operated (e.g. the vacuum safety switch is faulty, etc.).

For single chamber operation see the schematic S 5258.

Fig. 1

If several sources are to be operated in two or three coating plants by a single EHV 110 A high voltage supply, the high voltage from the rectifier will have to be supplied to the various sources via a high voltage switch station EHU (see separate operating instructions).

For multi-chamber operation see the schematic in the general plan 20-3090.

## 2. TECHNICAL DATA

Power supply (internal change-over)	3 x 380/220 V	50 Hz (3P+N+E)
	3 x 220 V	50 Hz (3P+E)
	3 x 415/240 V	50 Hz (3P+N+E)
	3 x 208 V	60 Hz (3P+E)
	3 x 230 V	60 Hz (3P+E)
Rated capacity for a complete evaporation equipment	18.5 kVA	
Rated capacity per additional evaporation source	0.7 kVA	
Nominal voltage of the high voltage unit	5 ÷ 11 kVDC ± 2% pre-selected	
Emission current	0 – 1.4 A DC variable	
Cooling water connection High voltage cabinet	13 mm φ hose connection	
Min. cooling water pressure	2 bar	
Max. cooling water pressure	4 bar	
Throughput	min. 12 litres/min at max. 50° C water intake temperature	

### 2.1. Dimensions

Rack cabinet	
Height	1 888 mm
Width	560 mm
Depth	688 mm
Weight, approx.	350 kg

## 3. POWER SUPPLIES

### 3.1. High voltage power supply EHV 110, U 2

#### 3.1.1. The front panel contains:

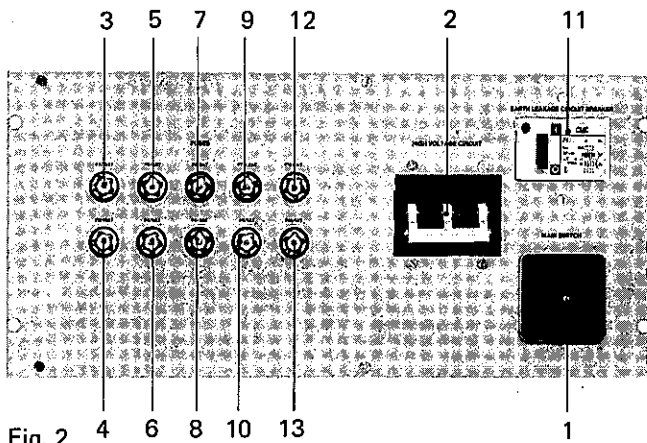

Fig. 2

- 1 Master switch (power supply input) (MAIN SWITCH)
- 2 Automatic circuit breaker F9 (Excess current cutout on the primary side of the high voltage transformer) Release current: 35 A (HIGH VOLTAGE CIRCUIT) with relay for safety circuit 2.

- 3 Fuse F 1, control and isolating transformer, primary side (T 2)
- 4 Fuse F 2, control and isolating transformer. Only used if the power supply has no neutral wire, otherwise the fuse is bridged over.
- 5 Fuse F 3 Tube heater T 4
- 6 Fuse F 4 Tube heater if the power supply has no neutral wire
- 7 Fuse F 5 Control circuit sec. 115 V
- 8 Fuse F 6 Control circuit sec. 98 V
- 9 Fuse F 7 Power feeding 180 V high voltage regulator 2E2
- 10 Fuse F 8 Power feeding 18 V high voltage regulator 2E2
- 11 Earth leakage circuit breaker F 20
- 12 Fuse F 18, fan tube
- 13 Fuse F 19, fan tube

#### 3.1.2. The rear panel contains:

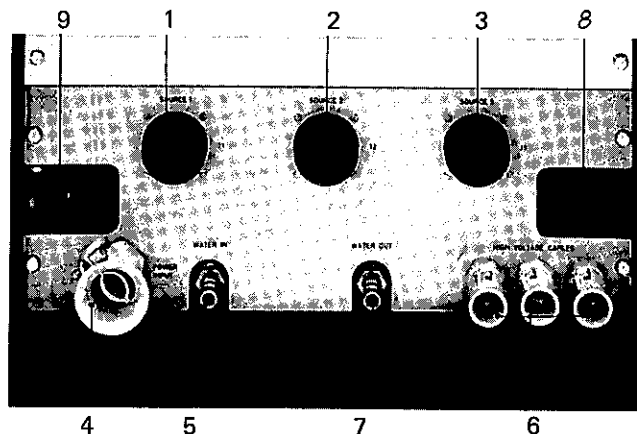

Fig. 3 Connection plate U 2

- 1 } Connection sockets for the control cable at the various evaporation sources / Coating plant (SOURCE 1, 2, 3)
- 2 }
- 3 }
- 4 Mains power supply input (POWER INPUT)
- 5 } Cooling-water for the high power triode (WATER IN, WATER OUT)
- 6 }
- 7 High voltage cable to sources 1, 2, 3 (HIGH VOLTAGE CABLES + GROUNDING)
- 8 Spare inlet (No control or sensor lines)
- 9 Cable lead-in for motor control and rate control for EKS

#### 3.1.3. The high voltage section U 2 of the high voltage current supply EHV 110 A contains the following components:

- 1 The high voltage transformer T 3
- 2 Power triode 3 CW 20 000 A 7 (Eimac)
- 3 Cathode heater transformer T 4 for the power triode
- 4 High voltage regulator (current limiting) 2 E 1 (S 5196)
- 5 Current supply high voltage regulator 2E2 (S 5197)
- 6 Measuring and regulating voltage divider 2E4 (S 5199)
- 7 Cathode bias voltage unit 2E3 (S 5198) with potentiometer R 5 for the emission-current instrument.

8. Time relay K 4 for the high voltage transformer T 3 stepped switching on.
9. High voltage rectifier rods D 1...D 6
10. Control transformer 115 V/97 V T 1
11. Isolating transformer for the cathode heater circuit T 2
12. Relay tube cooling K 5 (controlled by the water flow control)
13. Relay air cooling K 6 (controlled by the micro-switch S 2 of the tube cooling fan M 3)
14. Attenuation capacitors 4700 pF C 4...C 9
15. Load resistors 6 x 47 kΩ, R 15 ... R 20
16. Water resistance for tube cooling
17. Surge arrester for the grid of the triode F13
18. 2 transducers (1 for each gun) T 5...T 6 (spare space for T 7)
19. 3 high voltage connections for coating sources ESQ
20. Relay high voltage-ON first step K 1
21. Relay high voltage-ON second step K 2
22. Thermo relay F 21 for monitoring the first step K 1.
23. Series resistors for high voltage transformer ON.
24. High voltage indicator relay K 1 on printed circuit E 4
25. High voltage output for EHU
26. Door interlock switch (1st interlock circuit)
27. Door interlock switch (2nd interlock circuit)

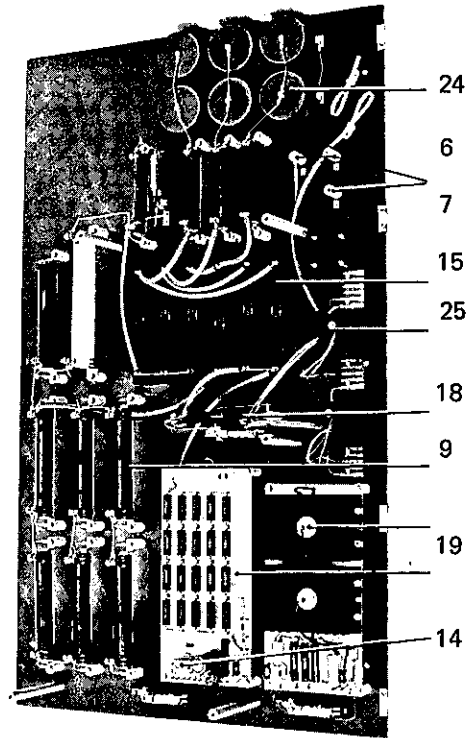

Fig. 5 High voltage plate EHV 110 A, U 2

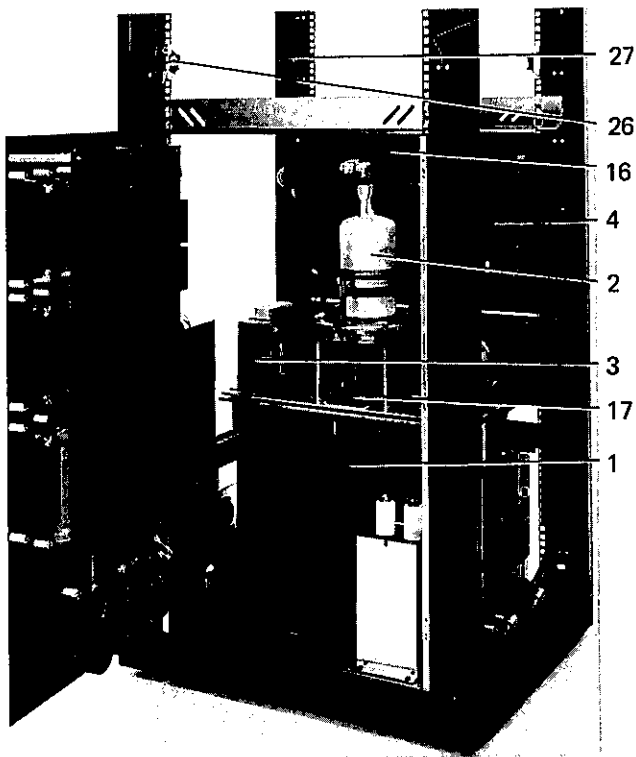

Fig. 4 Rear view EHV 110 U 2

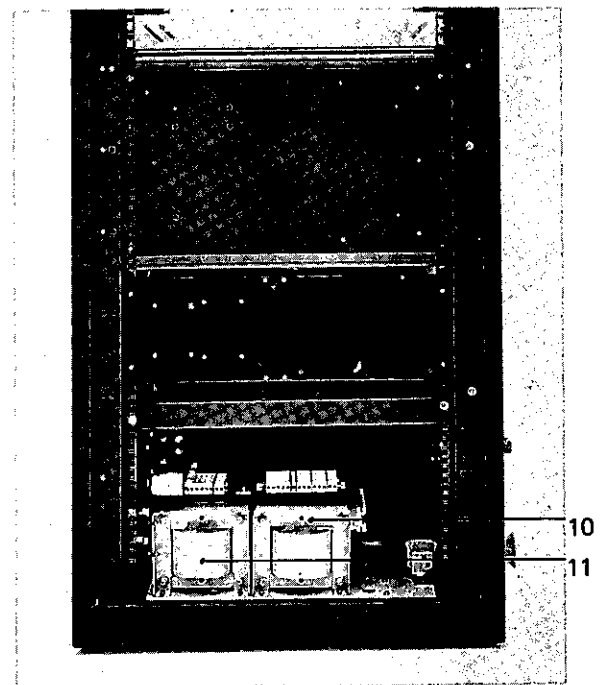

Fig. 6 Side view EHV 110 A, U 2

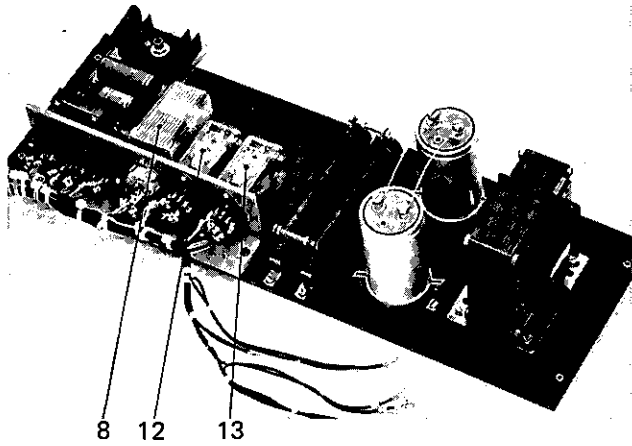

Fig. 7 Current supply for high voltage regulator E 1

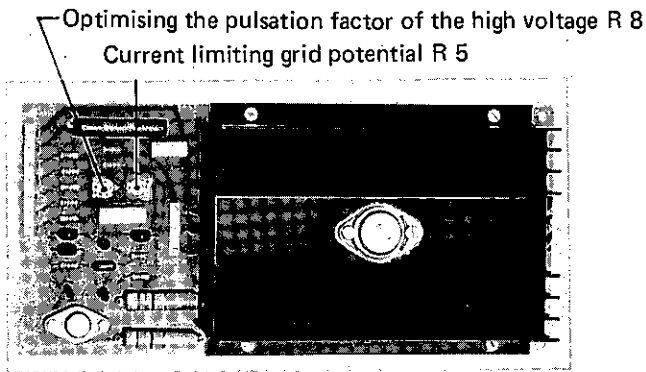

Fig. 8 High voltage regulator E 1

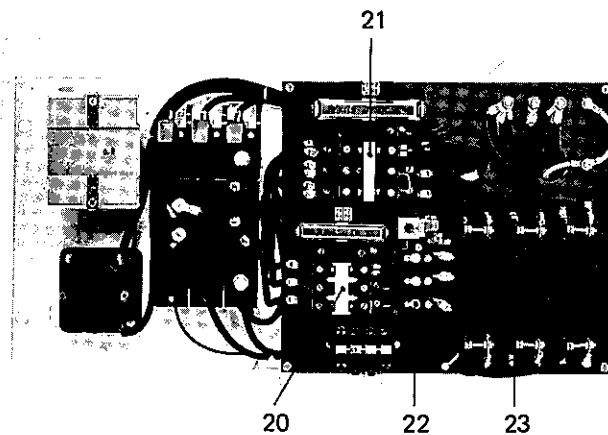

Fig. 8a Mains distributor rear side

### 3.2. High voltage power supply EHV 110 A, U 3 control section

#### 5.2.1. The front panel contains

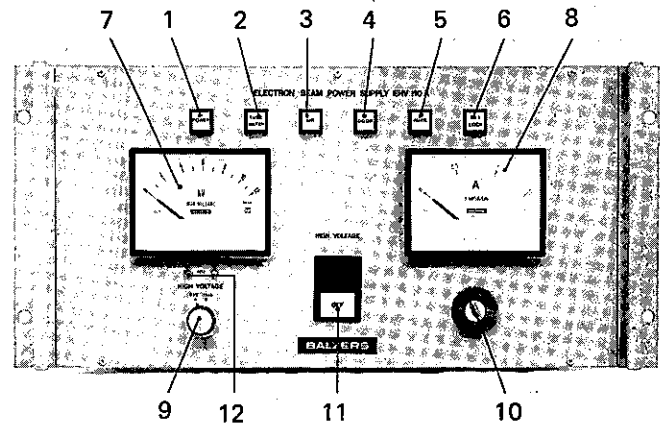

Fig. 9 Front panel of the high voltage control section EHV 110 U 3

- 1 Power supply signal lamp (POWER)
- 2 Signal lamp for the power triode cooling water (TUBE WATER)
- 3 Signal lamp for the power triode cooling air (AIR)
- 4 Signal lamp for the door switch in rack cabinet (DOOR)
- 5 Signal lamp for the external interlock circuit (AUXIL.)
- 6 Signal lamp for the high voltage key switch (KEY LOCK)
- 7 High voltage instrument 0 ÷ 12 kV (HIGH VOLTAGE)
- 8 Emission current instrument 0 ÷ 15 A (EMISSION)
- 9 High voltage selector switch (6 kV, 10 kV) (HIGH VOLTAGE)
- 10 Key switch for the high voltage
- 11 High voltage ON / OFF
- 12 2 adjustment potentiometers for adjusting two high voltage values between 5 and 11 kV.

#### 3.2.2. Functions of the signal lamps

- POWER** This lamp lights as soon as the mains power supply voltage is transmitted via the main switch (MAIN SWITCH).
- TUBE WATER** This lamp lights as soon as the main power supply is available and the cooling water supply to the power triode is satisfactory (monitored by the water flow control 1S1)
- AIR** This lamp lights as soon as the mains power supply and the cooling water are available and the fan is supplying sufficient cooling air to the power triode (monitored by the centrifugal switch 2S2 of the fan). This centrifugal switch also switches the relay 2K6 of the heating current for the power triode.

**DOOR** This lamp lights as soon as the preceding functions are completed and the door of the EHV 110 cabinet is closed (monitored by the door switches (S4 - S7).

**AUXILIARY** This lamp lights when the above functions are fulfilled and an external interlock circuit is closed (e.g. for rate control etc.) or the appropriate bridging contact is made.

**KEYLOCK** This lamp lights as soon as the preceding functions are completed and the high voltage key switch (10) is switched on. The plant is ready to transmit high voltage when the appropriate switching on signal (HIGH VOLTAGE ON) is received. If one coating plant only is to be used, the high voltage will be transmitted direct to the evaporation gun. In this case, the high voltage will be transmitted directly to the of the push-button 'HIGH VOLTAGE ON' of the EHV 110 A or by the push-button 'HIGH VOLTAGE ON' of the EKS units.

However, if two or three coating units are to be operated from one high voltage supply EHV 110 A, the high voltage will be transmitted to the HIGH VOLTAGE RELAY EHU through the push-button 'HIGH VOLTAGE ON' of the EHV 110 A. Only when the interlock circuit pertaining to an evaporation source (VAC., DOOR, KEYLOCK) is closed, can the high voltage be supplied to the appropriate gun from the EKS by pressing the pushbutton 'HIGH VOLTAGE ON'.

The timer K4 and the contactor K1 are switched on by pressing the pushbutton "HIGH VOLTAGE ON". During the time set on the timer K4, the mains power supply will then be connected to the high voltage transformer via the resistors R 1 ÷ R 6 (behind the front panel EHV, U 2). When the set time of approx. 0.3 sec has lapsed, the mains power supply will be connected directly to the high voltage transformer via the contactor K2. This cascade connection avoids excessive switching on stress on the high voltage rectifier. Without cascade switching, the rectifier would be at great risk.

The thermal switch F 21 controls the time relay K 4. As soon as the time relay K 4 falls off, the thermo switch F 21 will switch off the safety cutout F9 via the tripping relay. The safety cutout F9 can only be switched on again when the thermal switch F21 has cooled down.

The high voltage for the evaporation sources is accurately regulated at ± 1% via the high power triode. Regulation is accomplished by the high voltage regulator 2E1.

The normal load resistors R 15 ÷ 20, R 24, ensure voltage regulation when the high voltage output is open. Power is supplied to the high voltage regulator through the power supply printed circuit board E2 (Fig. 7, item 5).

The high voltage is measured by the measuring and regulating voltage divider E4 (Fig. 5, Item 6) and conducted to the high voltage regulator E1 (Figs. 4 + 8, Item 4) and to the high voltage measuring instrument (see the adjustment potentiometer R 23).

The cathode bias voltage unit E3 (Fig. 5, item 7) produces the cathode bias voltage (+ 54 volts relative to the grid), the signals for current limitation (R2/R3) and for excess current cutout R 1. The signal for current limitation (1.45 ÷ 1.55 A)

is conducted to the high voltage regulator E1 (rapid regulation of the triode if arcing occurs). The signal for overload current cut-out from the relay K1, switches a timer K6 (in the high voltage control unit EHV 110 A), which trips the high voltage control circuit at an excess current of more than 0.6 sec. The overload current cutout should be set at 1.4 ÷ 1.45 A (adjustable on the potentiometer R9). The excess current cutout prevents the high voltage falling (when the high voltage current is over 1.4 A). Hence, reliable spot focussing in the evaporation source is ensured.

The two adjustment potentiometers Fig. 9, Item 12, below the high voltage measuring instrument permit an extensive change of the high voltage of approx. 4.5 kV ÷ 11 kV. With the high voltage selector switch Fig. 9, Item 9, the values adjusted can then be consecutively set and in switch position (10 kV), the Wehnelt voltage set on the EHS will be connected to the gun. In switch position (6 kV) the Wehnelt voltage is always null.

**3.5.3. The rear panel contains**

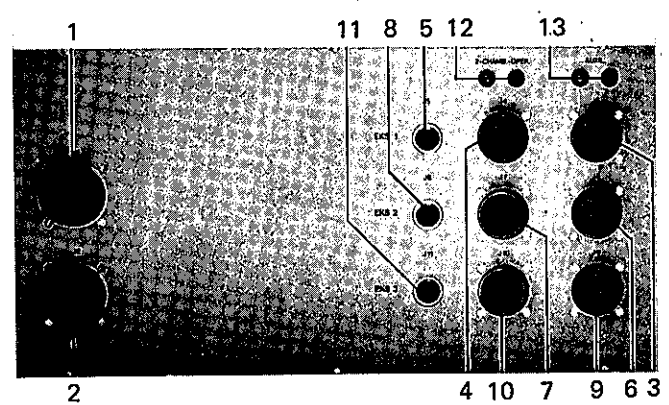

Fig. 10 Rear panel of the EHV 110 A, U 3

- 1. J 1
  - 2. J 2
  - 3. J 3
  - 4. J 4
  - 5. J 5
  - 6. J 6
  - 7. J 7
  - 8. J 8
  - 9. J 9
  - 10. J 10
  - 11. J 11
  - 12. Multi-chamber operation
  - 13. Auxiliary
- } Cabinet internal wiring
- } see the general plan (20 - 3090)

In multi-chamber operation, the connections J 4, J 7, J 10 (High voltage control unit) to the appropriate EKS are not made. In this case, special blind plugs are necessary for the connection sockets J 4, J 7 and J 10 of the high voltage control. Also, in multi-chamber operation, the by-pass "multi-chamber" must be made. If the interlock connection "Auxiliary" is not required, this bridging must be undertaken on the rear panel of the high voltage control unit.

3.2.4. The control section of the high voltage supply EHV 110 A, U 3 contains the following components:

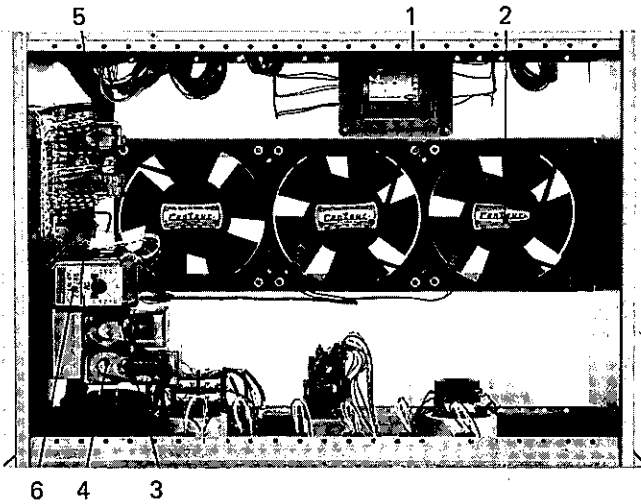

Fig. 11 Control section high voltage EHV 110 A, U 3

- 1 Transformer for the rotary drive motor power supply
- 2 3 fans
- Relay plate:
- 3 K3, Automatic switching relay 'High voltage ON'
- 4 Relay K4, COAT-O-MATIC
- 5 Overload current cutout
- 6 Time relay for overload current cutout K6.

4. MOUNTING THE HIGH VOLTAGE TUBE (TRIODE)

The high voltage tube is shipped separately packed and must be inserted into the socket before the start-up.

Before mounting, pull the cap-type gasket over the high voltage tube according to Fig. 12. Shorten the spring of the cap-type gasket by 60 mm.

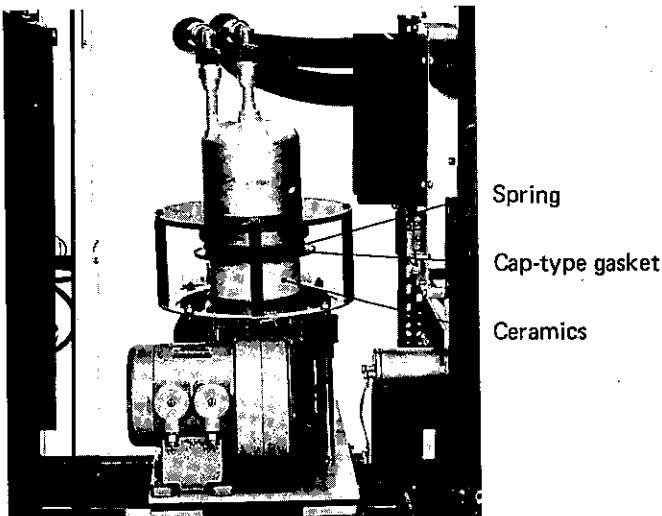

Fig. 12

Make sure the cap-type gasket is mounted correctly, to ensure that the condensed water flows from the ceramics as quickly as possible. Incorrectly mounted or missing cap-type gaskets will cause high voltage arcing on the high voltage tube.

5. START-UP PROCEDURE

The start-up is made according to separate installation and starting instructions, e.g. BB 800 066 BE.

If none of these examples agrees with the delivered electron beam evaporation system, stick to the instructions given for the units delivered.

6. TROUBLE SHOOTING

Under operating conditions, i.e. when the high voltage is switched on, there are large metallic surfaces under high voltage in the control cabinet EHV 110. Contact with these high voltage carrying components is fatal. For this reason, although the rear door has a safety switch, it should only be opened when the high voltage is switched off (the action of opening the door switches off the voltage). As it is not necessary to open the rear door for normal operation of the power supply (all fuses, switches etc. are on the front panel where they can be easily and conveniently operated from outside the plant), the key for the rear door should not be kept in the plant. It is only necessary to open the rear door for service or installation work, which may only be undertaken by suitably qualified personnel.

When trouble-shooting, it may sometimes be necessary to make measurements with the power supply open. Measurements of this type or the re-adjustment of adjustment potentiometers may only be carried out by personnel with the necessary qualifications. Under no circumstances may measurement connections be either made or disconnected whilst the high voltage is switched on, neither may the various measuring instruments be touched during measurement.

Measuring lines must always be laid so that they are a few centimeters away from the high voltage carrying components. When taking measurements on high voltage carrying parts, make sure that the gauge is always placed outside the rack cabinet and the back and side doors are closed.

Ensure that high voltage measurements are done only when two persons are present.

Fault	Cause	Correction
High voltage ON is not operating (The OFF lamp does not light)	The automatic circuit breaker <b>HIGH VOLTAGE CIRCUIT</b> is not switched on  Break in the control circuit (signal lamps do not light)	Switch on the automatic breaker  Check the control circuit accord- ing to diagram
Automatic breaker F 9 switches off (high voltage off)	Short circuit in the high voltage transformer  Break in 2 nd interlock circuit  Time relay K4 responds (step 1 remains on, relay K2 does not respond)	Change the high voltage trans- former.  Trace the fault as to diagram and repair.
High voltage cannot be adjusted to 6 kV	Water resistance (elec.) for tube cooling too low ( $r = 2 \text{ M}\Omega$ at least $280 \frac{\text{K}\Omega \text{ cm}^2}{\text{m}}$ )  Z-diode on cathode bias unit E3	Use clean water  Change Z-diode or p.c. board
Earth leakage circuit breaker F20 switches off, all safety circuit lights go out.	Faulty insulation (earth contact) in control circuit 115 V, 97 V or in cathode heater circuit 220 V.	Repair insulation
High voltage not adjustable, remains at 11 kV	Output transistor on high voltage regulator E 1 defective	Change the high voltage p.c. board, or replace transistor
Output transistor on high voltage regulator E 1 faulty	Arcing on the high voltage tube between anode and grid due to condensed water because of faulty or missing cap-type gasket	Dry the tube, mount or change the cap-type gasket.

## 7. SPARE PARTS

Please order your spare parts according to the enclosed spare parts list.

Always state type and serial number as indicated on the name plate of that unit.

### Ordering example:

1 potentiometer, 2 k $\Omega$ , 1 W, order nr. B 4886 320  
R3, as per spare parts list BB 800 041 E/12, Item 246.

## High voltage power supply unit EHV 110 A

### Instruction for voltage commutation to different mains voltages

(see schematic drawing BG 241 240-S and BG 241 241-S)

The standard power supply EHV 110 A is prepared for connection to a voltage of 3 x 380/220 V, frequency 50 Hz. If different voltages and frequencies are required, the following steps have to be carried out in the rack:

1. Voltage 3 x 208 V, 3 x 220 V, 3 x 230 V with or without neutral wire
  - 1.1. Exchange the three-phase automatic fuse F9 (on front panel "Main Switch") with a rating of 50 Amp.
  - 1.2. Remove bridging of fuses F2, F4 and F19 (on front panel "Main switch").
  - 1.3. Switch the high voltage transformer T3 on the terminal board:
    - a) Change the three lugs ( $\Delta/\Delta$ ) to position  $\Delta$ .
    - b) Clamp the three lugs for voltage selection to the corresponding tapping. The terminal board is accessible by removing the right rack board.
  - 1.4. Transformer T1, T2 (at lower right side of rack bottom) and filament-heating transformer T4 (behind high voltage tube): Clamp to tapping 208, 220 or 230 V at primary winding.
  - 1.5. Commutation to contactor board (behind front panel "Main Switch"), accessible from the rear: Commutate flexible connection from screw bolt N to screw bolt S (existing twice).
  - 1.6. Exchange nameplate on rear door of rack for one with correct mains data.
2. Voltage 3 x 415/240 V with neutral wire
  - 2.1. High voltage transformer T3: Change the three lugs for voltage selection to tapping 248 V (the other three lugs remain in position  $\Delta$ ).
  - 2.2. Clamp transformers T1, T2 and T4 to tapping 240 V at primary winding.
  - 2.3. Exchange nameplate on rear door of rack for one with correct mains data.
3. Main frequency 60 Hz
  - 3.1. Control transformer T1: Change connection of secondary winding from 97 V to 115 V.
  - 3.2. Exchange nameplate for one with correct mains data.





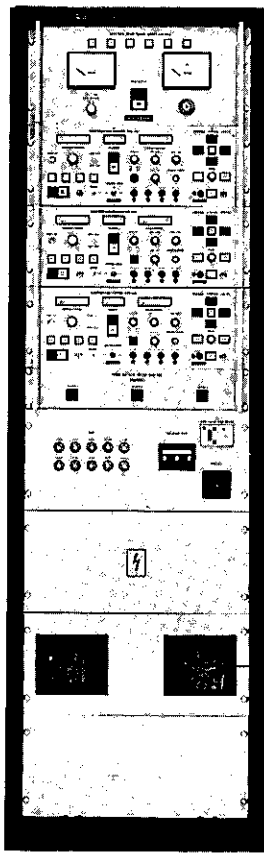

7,8

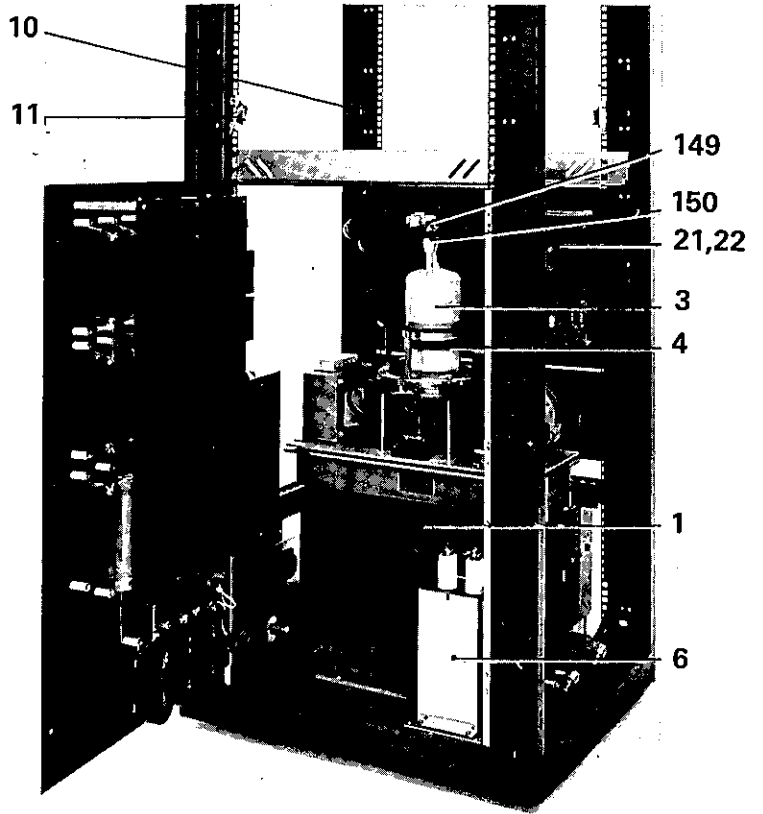

10

11

149

150

21,22

3

4

1

6

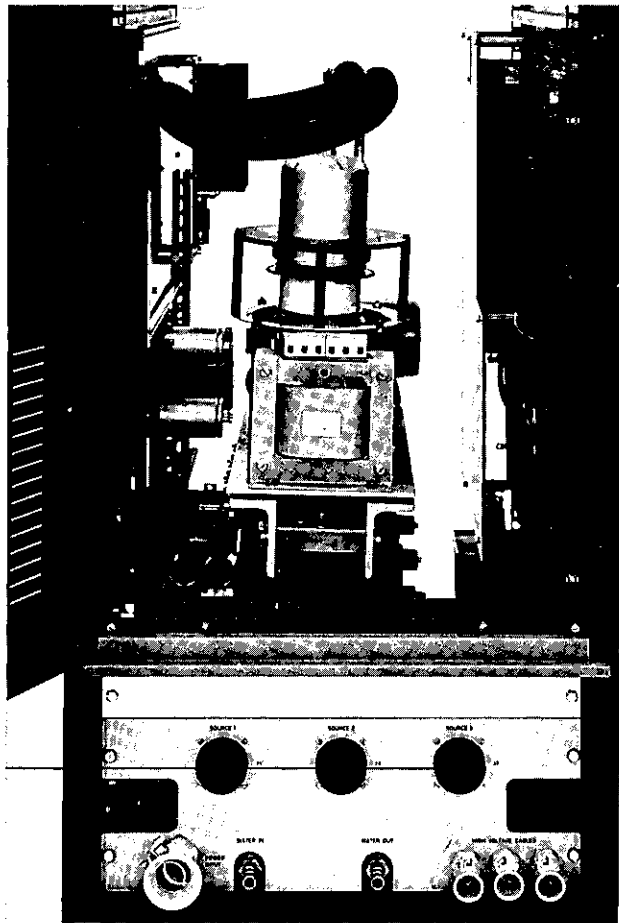

13



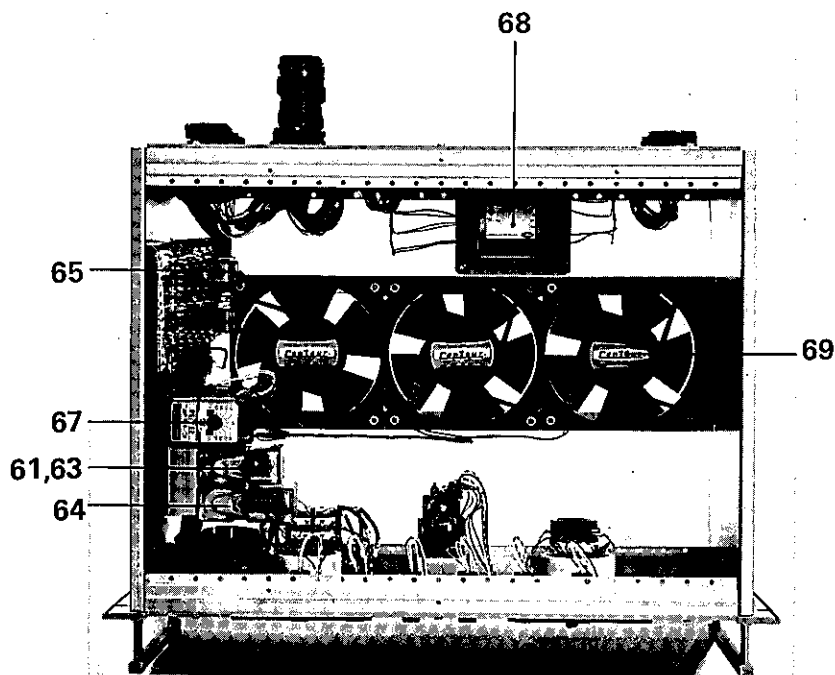
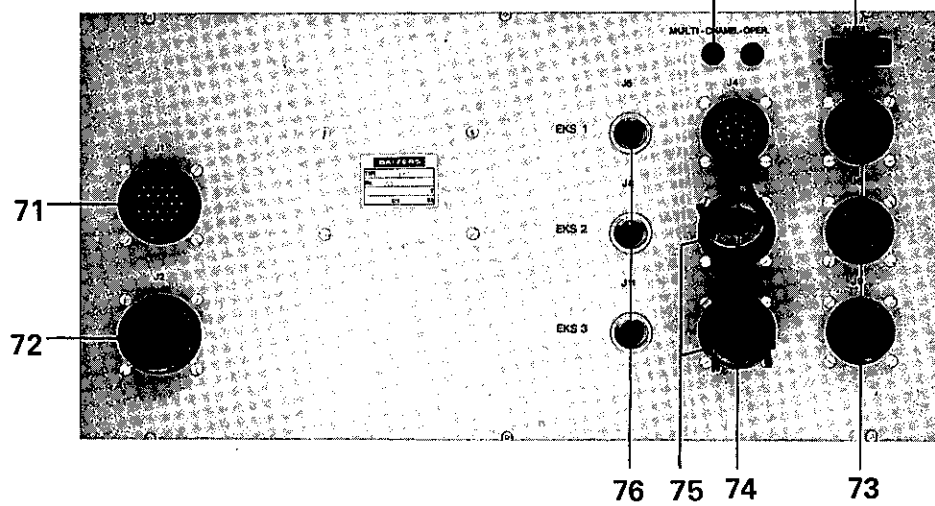
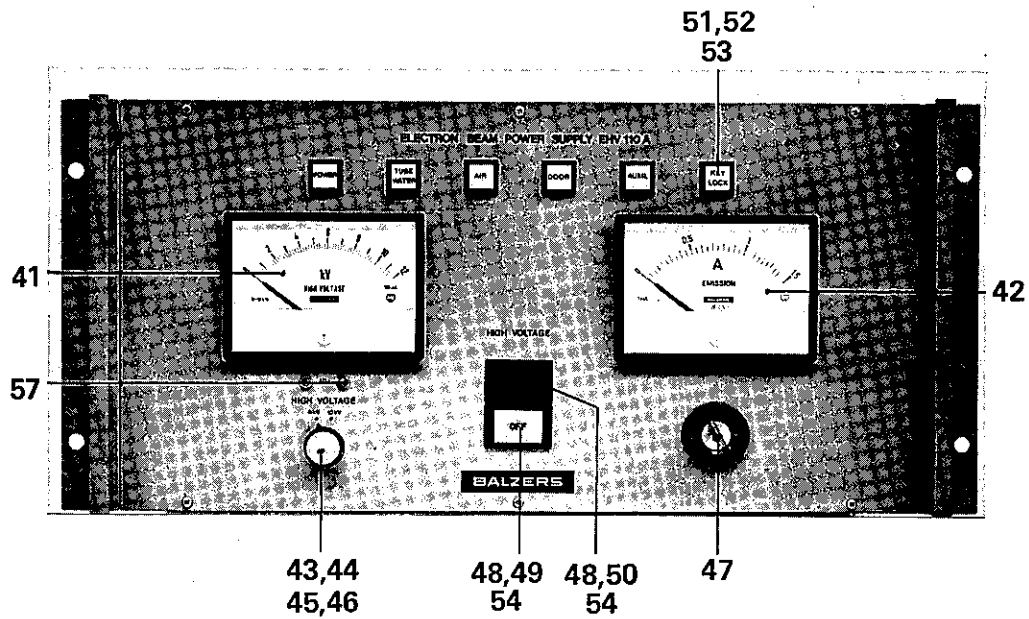

Electron beam power supply / HS-Steuergerät EHV 110 A, U3

BB 800 060 E/4

	Description Teil	Item Pos.	Code-No.	Bestell-Nr.	S	Remarks Bemerkungen
1	Earth leakage circuit breaker / Fehlerstromschutzschalter					
	FI 10, 115 V, 3P + N	91	B 4668 801-AF			
1	Switch / Schalter C41 - A 202 -E	92	B 4743 501 KA			
1	Knob / Griff S 1 C, G002, red / rot	93	B 4743 012 KA			
1	Protection switch / Schutzschalter	94				
	Typ CF3 - G2-G3-G6-35-3, 35A, 380V, 50 Hz		B 4668 101 CS			
6	Fuse holder / Gerätesicherungslampe 200 - 500 V	95	B 4661 212 AQ			
3	Fuse holder / Gerätesicherungslampe 100 - 250 V	96	B 4661 212 AN			
1	Fuse holder / Gerätesicherungslampe 12 - 24 V	97	B 4661 212 AE			
		98				
2	Fuse / Sicherung 6,3 A slow / Träge	99	B 4666 471 ES			
2	Fuse / Sicherung 10 A slow / Träge	100	B 4666 471 FA			
3	Fuse / Sicherung 1 A slow / Träge	101	B 4666 436			
1	Fuse / Sicherung 1,6 A slow / Träge	102	B 4666 440			
2	Fuse / Sicherung 3,15 A slow / Träge	103	B 4666 446			
		104				
1	Conductor / Schütz CA1 - 10, 115 V, 60 Hz	105	B 4771 063 GP			
1	Conductor / Schütz CA1 - 16, 115 V, 60 Hz	106	B 4771 063 GT			
1	Conductor / Schütz M1, 3NO/1NC, 115 V, 60 Hz	107	B 4770 202 AD			
1	Thermo relay / Thermorelais CT1-10, 1,6-2,4 A	108	B 4776 510 GT			
		109				
6	Resistor / Drahtwiderstand, 6,8 Ω , 50 W	110	B 4837 068 XV			

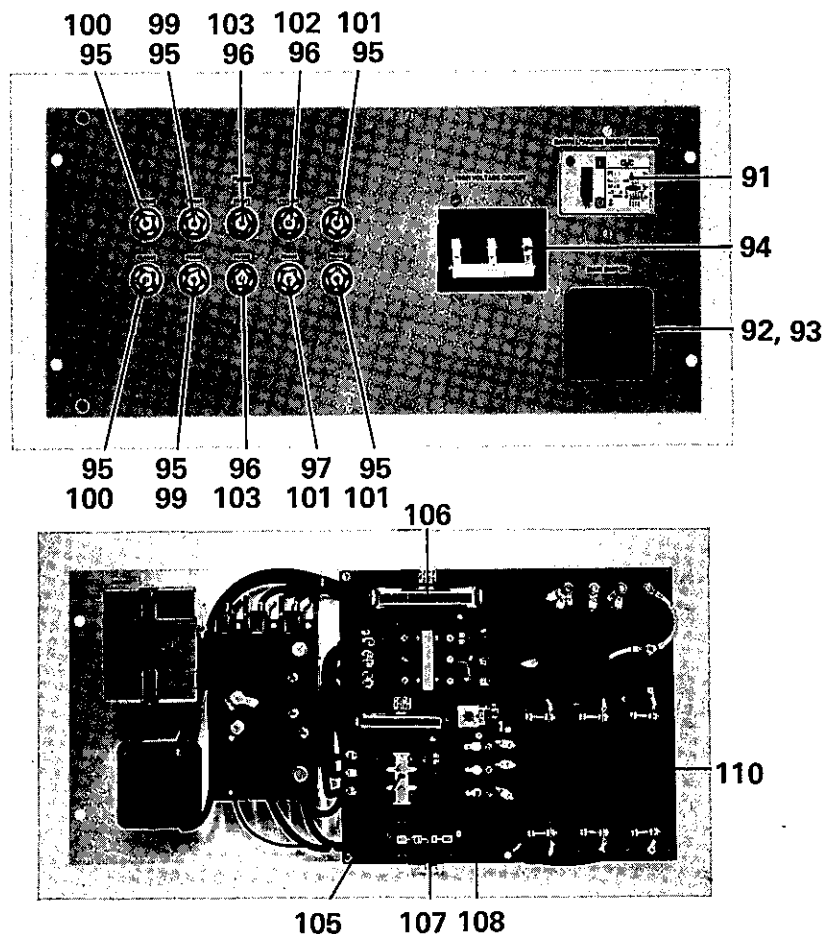

Spare Parts for / Ersatzteile zu EHV 110 A

Power supply / Netzverteiler

20 - 3451 R1

BB 800 060 E / 5

	Description Teil	Item Pos.	Code-No.	Bestell-Nr.	S	Remarks Bemerkungen
1	Transformer / Steuertransformator	121	B 5128 550 SG			
1	Transformer / Trenntransformator	122	B 5132 600 FA			
3	Capacitor / Kondensator 1 $\mu$ F, 640 V	123	B 4985 610 XE			
3	Resistor / Widerstand 10 $\Omega$ , 12 W	124	B 4836 110 WY			
		125				
3	Lightning arrester / Überspannungsableiter, Q69-x53	126	B 5013 801 23			
3	Socket / Fassung Q 81 -x 175	127	B 5024 853 75			
		128				
1	Terminal / Klemme yellow/gelb VR1-16	129	B 4653 704 04			
3	Terminal / Klemme grey/grau VR1-16	130	B 4653 704 08			
1	Terminal / Klemme green/grün VRE1-16	131	B 4653 714 05			

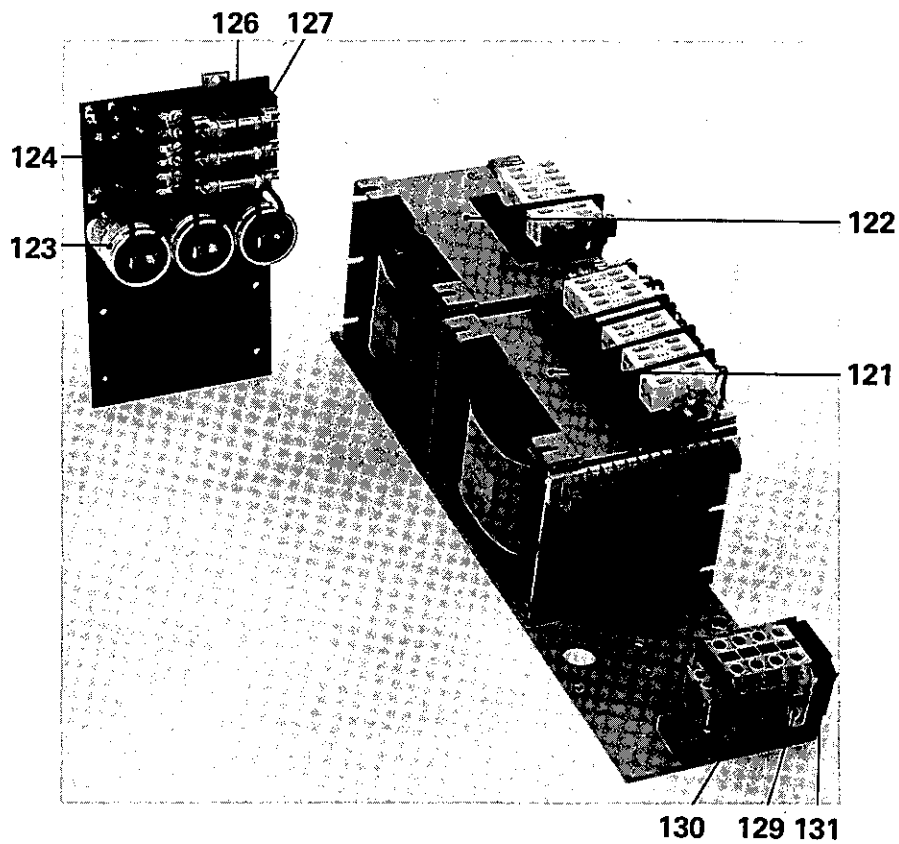

Spare Parts for / Ersatzteile zu EHV 110 A		
Transformer unit / Transformatoreinheit	20 - 3465 R1	BB 800 060 E / 6

	Description Teil	Item Pos.	Code-No.	Bestell-Nr.	S	Remarks Bemerkungen
1	Hose / Schlauch, $\phi$ 10/12, L = 10,5 m	141	B 2358 252 NV			
1	Hose / Schlauch, $\phi$ 13,5/39,5, L = 0,9 m	142	B 2361 054 NA			Armaflex
1	Hose / Schlauch, EF-3/8", L = 0,5 m	143	B 4615 811 SD			Anaconda
		144				
16	Insulator / Isolator, $\phi$ 12 x 25	145	B 4624 121 12			
4	Nut / Anschlussmutter SO 18.20 - 12	146	B 4117 572 MX			
4	Clamping ring / Klemmring SO 18.1 - 12	147	B 4119 369 -X			
4	Sleeve / Stützhülse, SO 18.3 - 12/9	148	B 4119 421 -X			
4	Nipple / Einstellwinkel	149	B 4106 423 MX			see BB 800 060 E / 2
2	Nipple / Muffe	150	BG 203 481 -R			siehe BB 800 060 E / 2

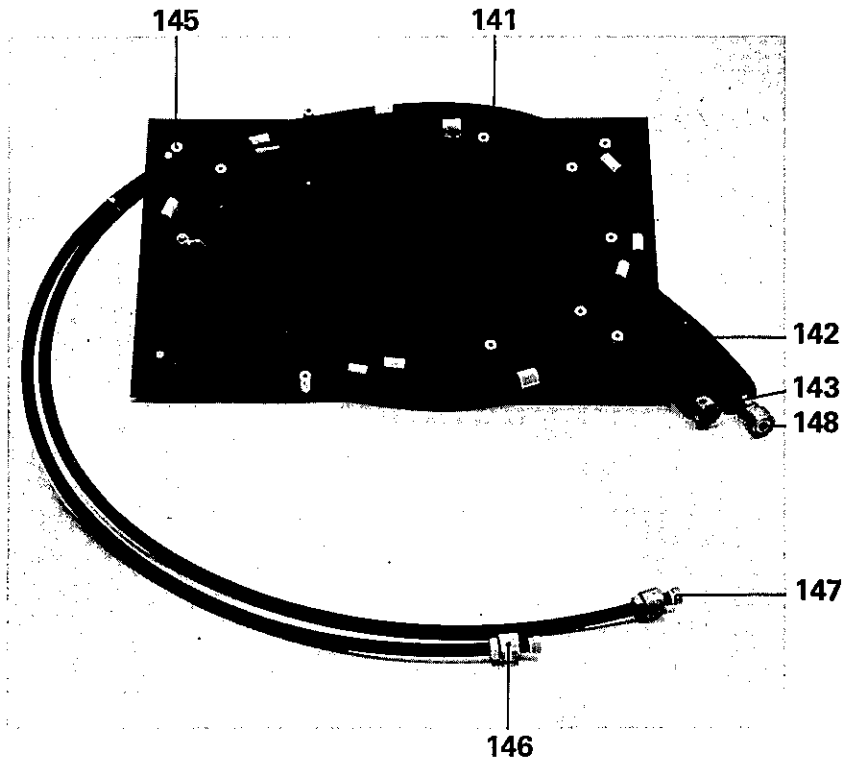

Spare Parts for / Ersatzteile zu

Water resistor / Wasserwiderstand

20 - 3460 R1

BB 800 060 E / 7

	Description Teil	Item Pos.	Code-No.	Bestell-Nr.	S	Remarks Bemerkungen
6	High voltage rectifier / HS-Gleichrichter	151	B 5036 269 JS			
6	Capacitor / Kondensator, 4800pF, 20kV DC,	152	B 4959 348 8R			
		153				
2	Resistor / Widerstand 25 $\Omega$ , 50 W	154	B 4836 125 XY			
3	Resistor / Widerstand 47 $\Omega$ , 50 W	155	B 4837 147 XW			
1	Resistor / Widerstand 10 $\Omega$ , 100 W	156	B 4837 110 YJ			
6	Resistor / Widerstand 47 k $\Omega$ , 100 W	157	B 4837 447 YL			
2	Resistor / Widerstand 8,4 M $\Omega$ , 25 W	158	B 4826 684 XA			
2	Transductor / Transduktor, DI - 3585	159	B 5139 101 DH			
4	Lightring arrester / Überspannungsableiter Q69 -x 52	160	B 5013 801 22			
4	Socket / Fassung, Q 81 -x175	161	B 5024 853 75			
37	Insulator / Isolator $\phi$ 12 x 25	162	B 4624 121 12			
		163				
3	Terminal strip / Steckerleiste 444 A/LF	164	B 4716 121 A			
		165				
1	Voltage divider / Regelspannungsteiler	166	20-3200 R1			
1	Relay / Relais, FR 11P, 8000G, 110V DC,	167	B 4782 135 KA	enclosed in item 166		
		168				
1	Cathode bias / Kathodenvorspannungseinheit	169	20-3202 R1			

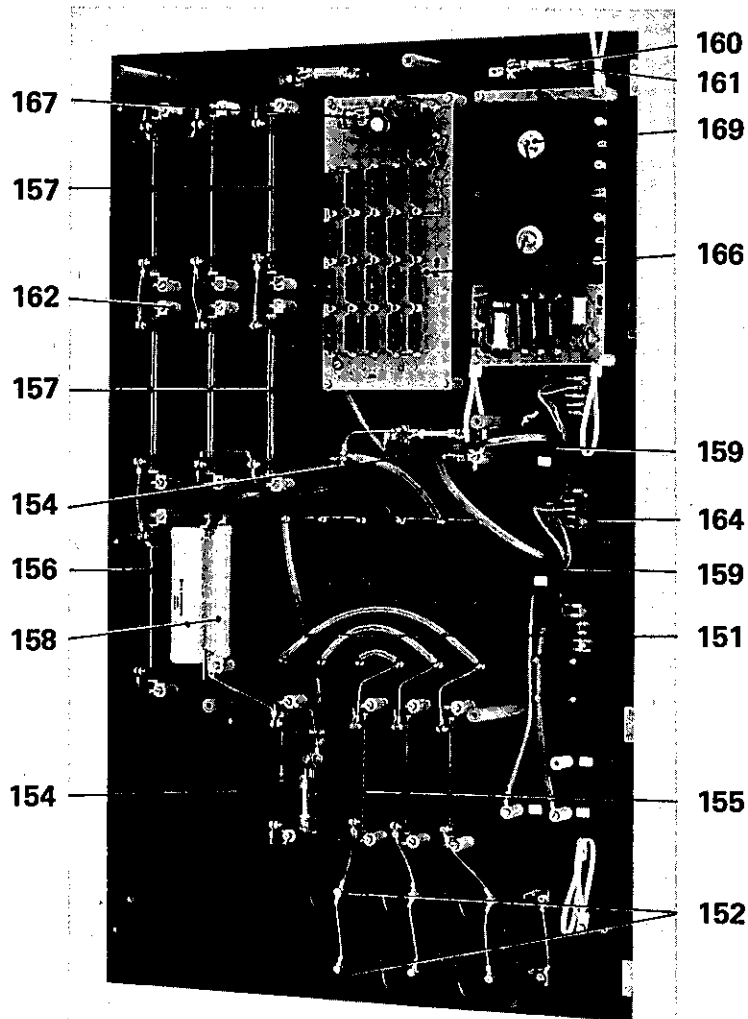

Spare Parts for / Ersatzteile zu EHV 110 A

High voltage plate / Hochspannungsplatte

20 - 3453 R1

BB 800 060 E / 8



	Description Teil	Item Pos.	Code-No.	Bestell-Nr.	S	Remarks Bemerkungen
1	High current transformer / Hochstromtransformator	171	B 5128 300-HL			
		172				
1	Turbo fan / Turbogebläse WE 4040 TR, 220 V, 50-60Hz	173	B 5099 401 EA			
1	Lightning arrester / Überspannungsableiter Q69-x52, 350 V	174	B 5013 801 22			
1	Socket / Fassung, Q81 -x 175	175	B 5024 853 75			
		176				
2	Capacitor / Kondensator 470 nF, 630 V	177	B 4931 547 W8			
2	Capacitor / Kondensator 1 $\mu$ F, 250 V	178	B 4931 610 R8			
1	Resistor / Widerstand 10 $\Omega$ , 12 W	179	B 4836 110 WY			
		180				

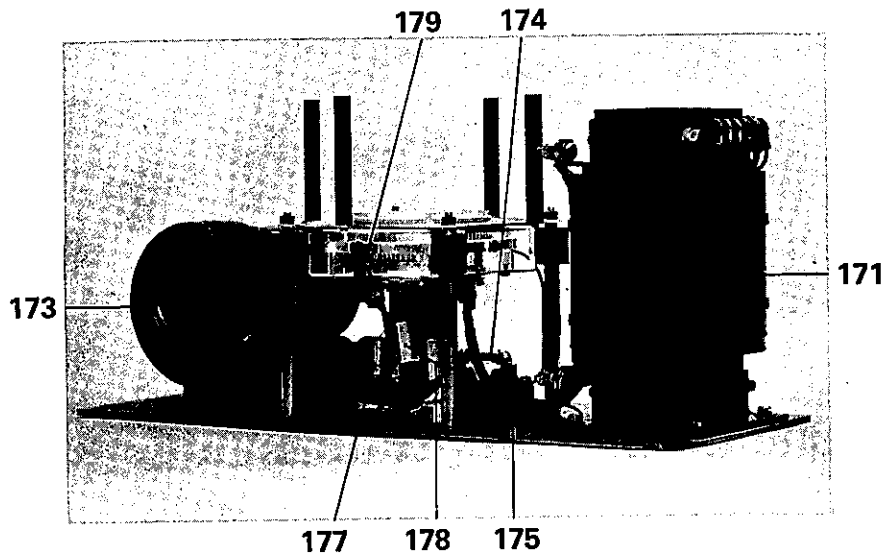

Spare Parts for / Ersatzteile zu EHV 110 A

Triode plate / Triodenplatte kompl.

20-3470 R1

BB 800 060 E / 9

	Description Teil	Item Pos.	Code-No.	Bestell-Nr.	S	Remarks Bemerkungen
1	Set print unit / Sollwertspannungsprint	191	20-3206 R1			
1	Smoothing reactor / Glättungs-drossel 20-2771	192	B 5142 750 DG			
2	Capacitor / Kondensator 1000 $\mu$ F, 250/275 V	193	B 4902 510 Y7			
2	Resistor / Widerstand 220 $\Omega$ , 100 W	194	B 4837 222 YL			
		195				
2	Relay / Relais KR 11 S, 110 V, 60 Hz	196	B 4783 187 HA			
1	Time relay / Zeitrelais JUP-8B1 UF, 0,04 - 3 sec.	197	B 4779 521 EJ			
		198				
1	Terminal strip / Steckerleiste	199	B 4717 181 PE			

191 197 196 194 193 192

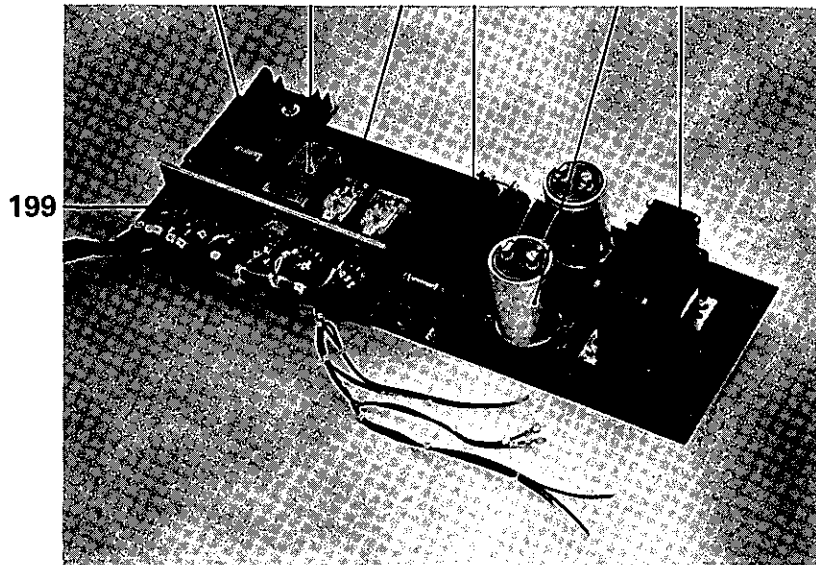

Spare Parts for / Ersatzteile zu EHV 110 A

Power supply for  
High voltage regulator / Stromversorgung HS-Regler 20 - 3463 R1

BB 800 060 E / 10

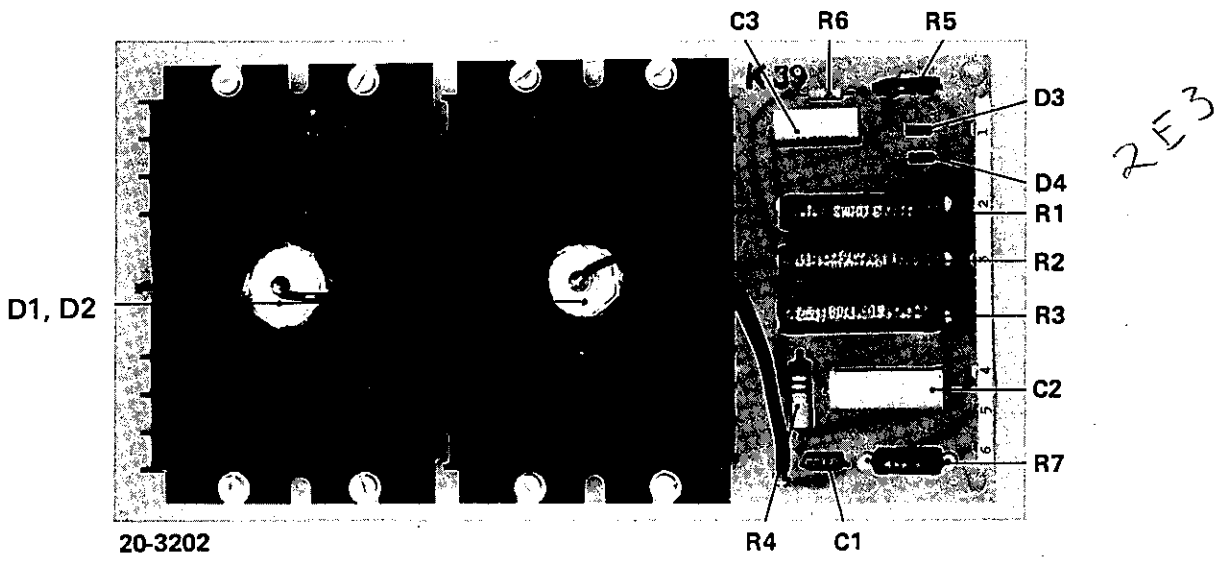
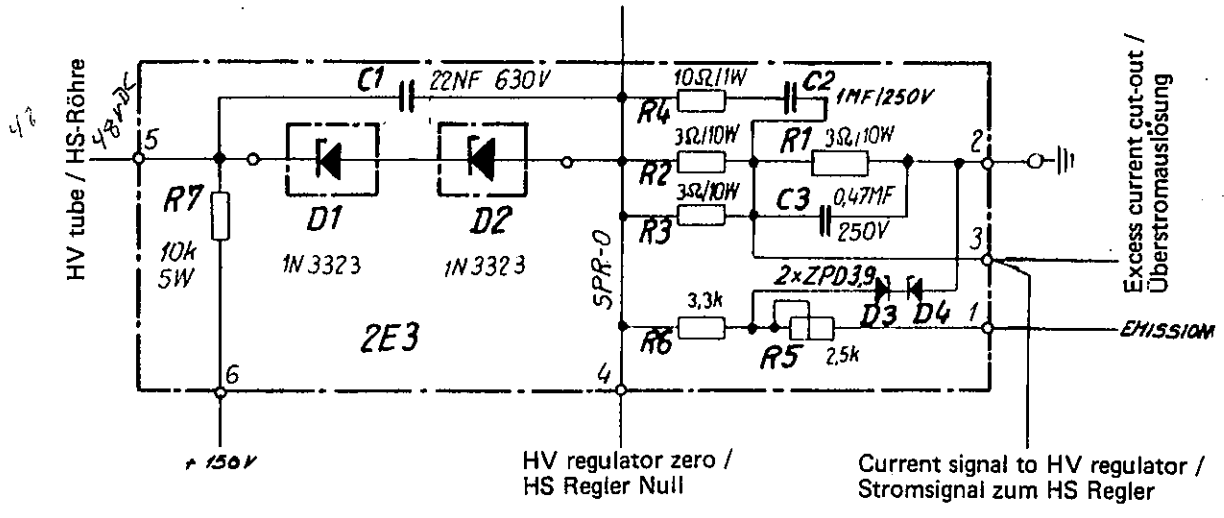

Cathode bias (High voltage regulator power supply) / Kathodenvorspannungseinheit BG 241 241 DS

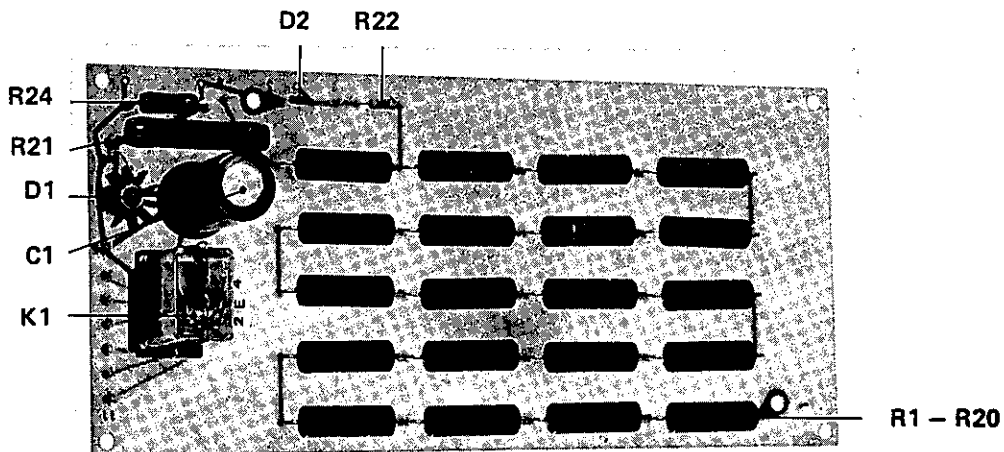
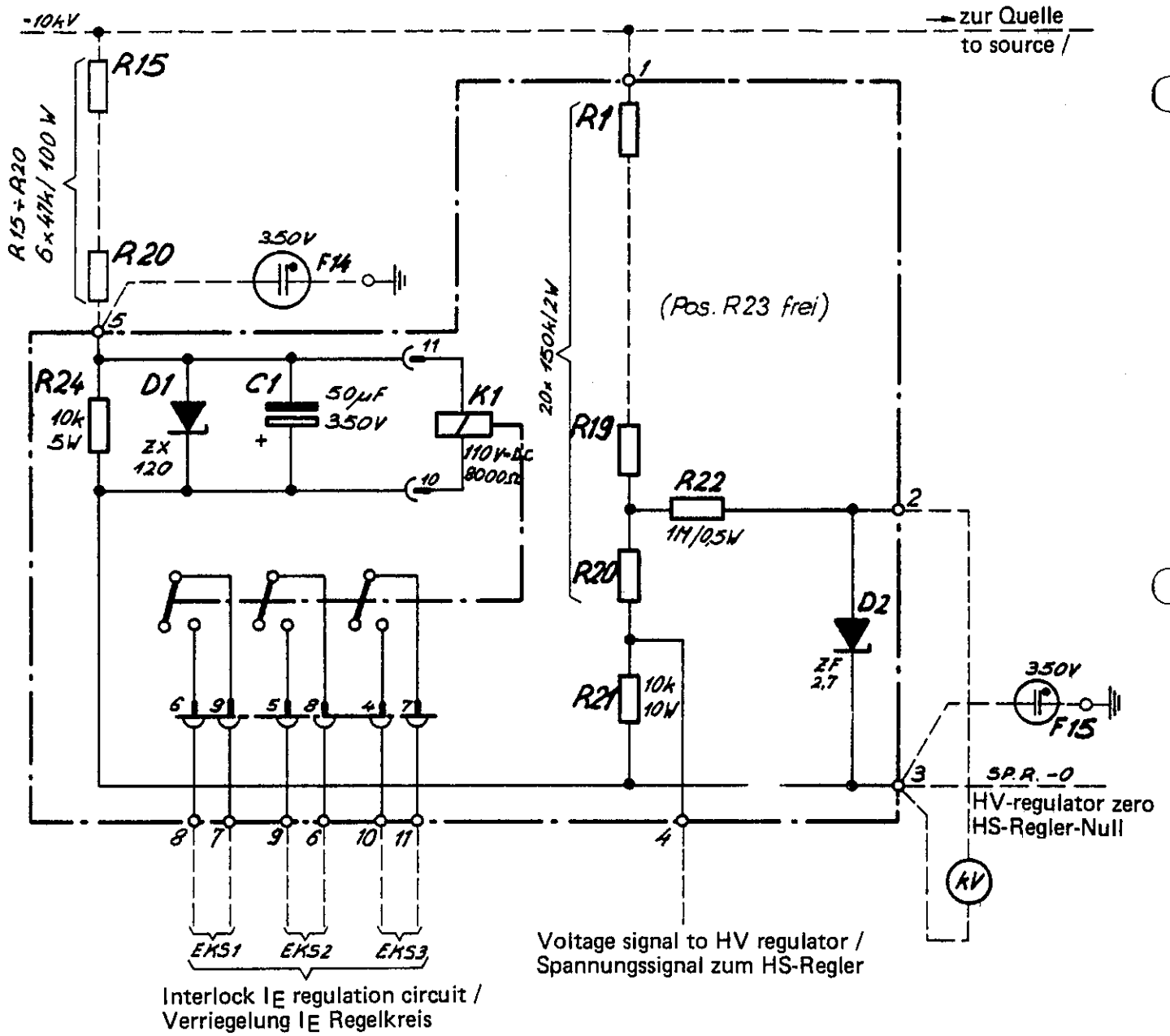

20-3200

High voltage divider / Regelspannungsteiler

BG 005199 AS

Power supply HV regulator /

Stromversorgung -  
HS-Regler BG005 197-S

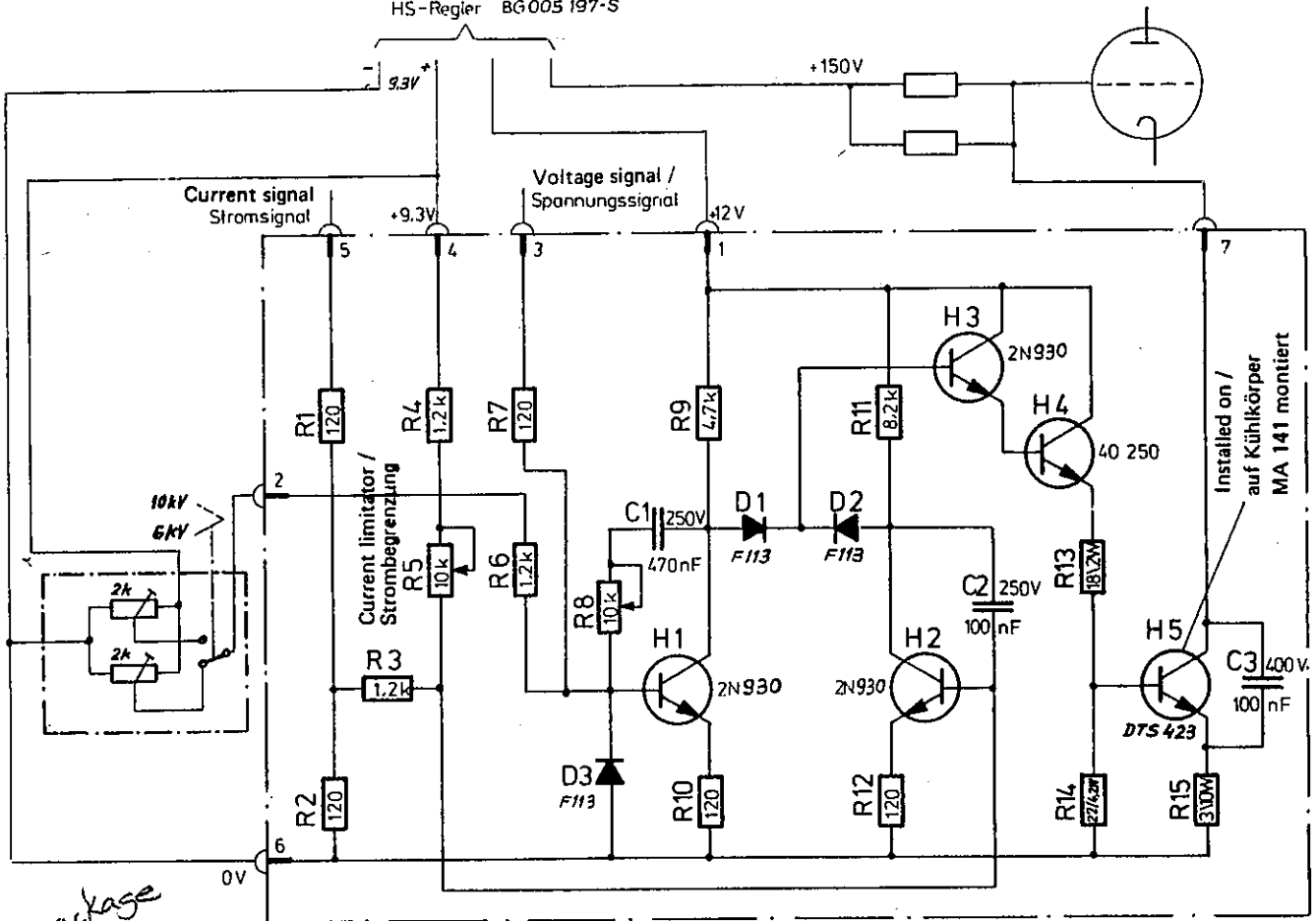

All resistors 0,5 W if not indicated otherwise /  
Alle Widerstände 0,5 W sofern nichts anderes angegeben

*every TO-3 package  
96K6949  
1000V  
2Amp \$24.75*

*NTE/mosFets  
Newark part # 66-00049-1*

*H5  
BUZ45A  
E9649*

*H4  
2N3054A  
8513*

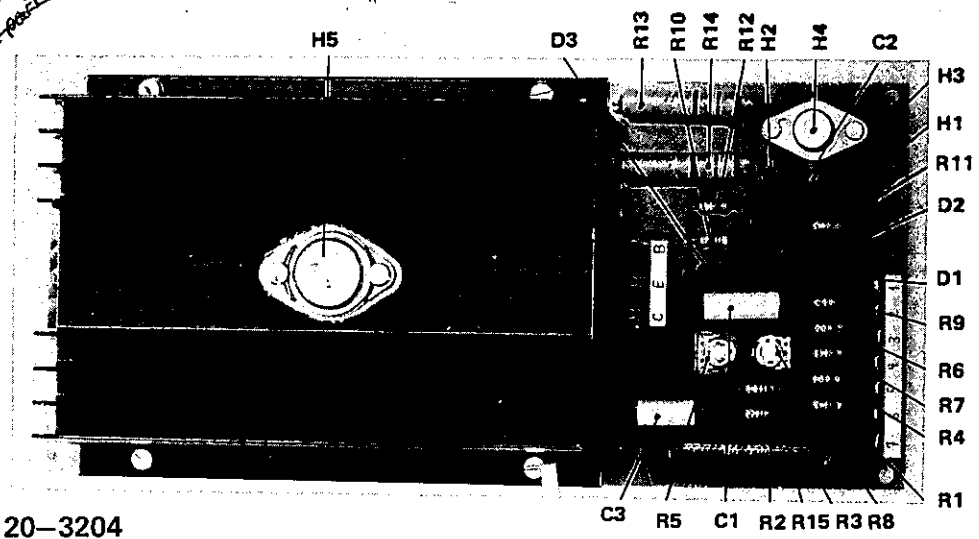

20-3204

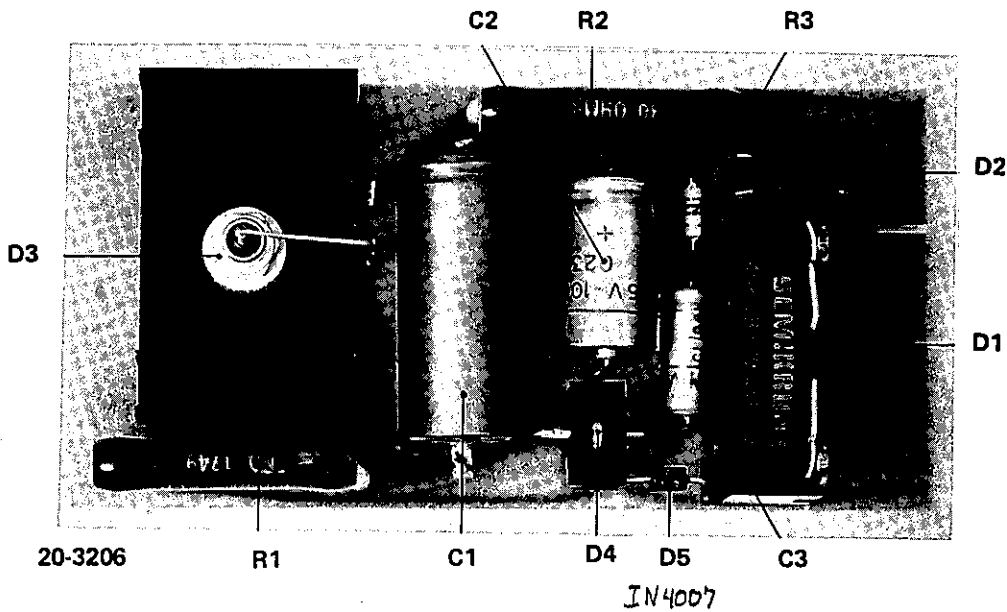
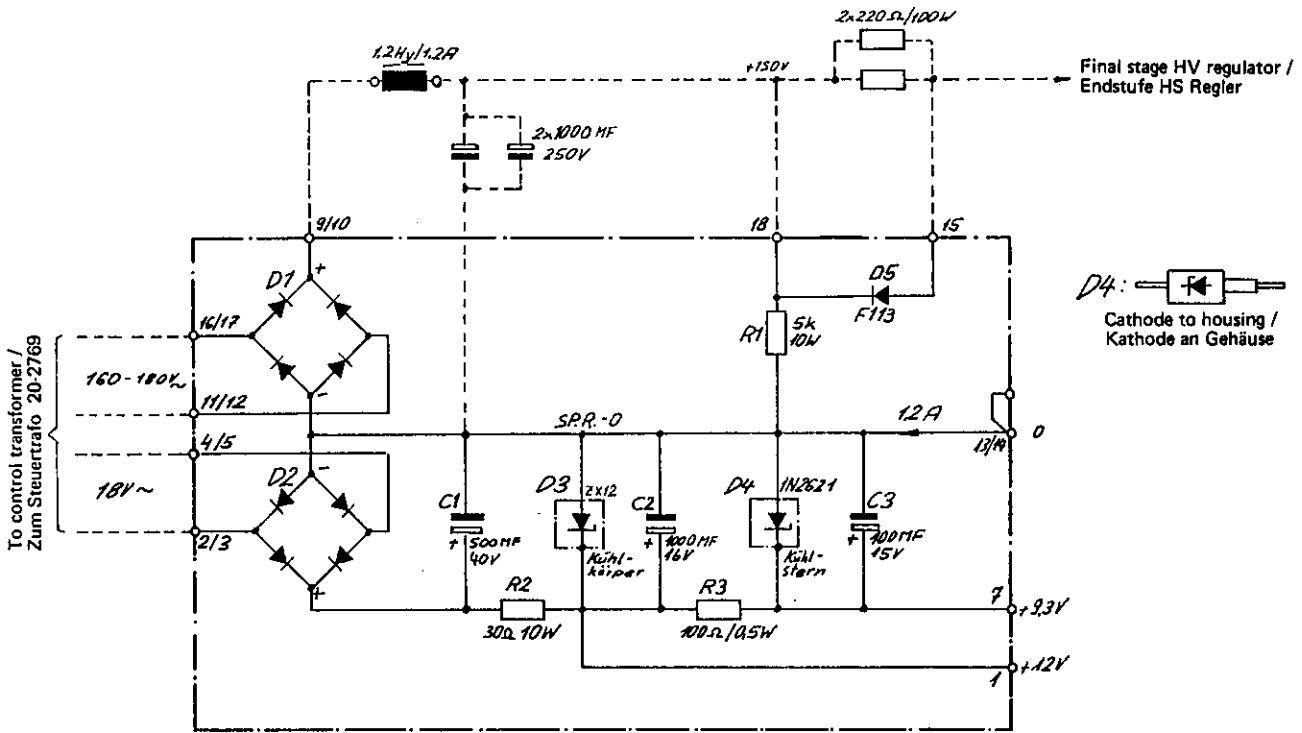

267

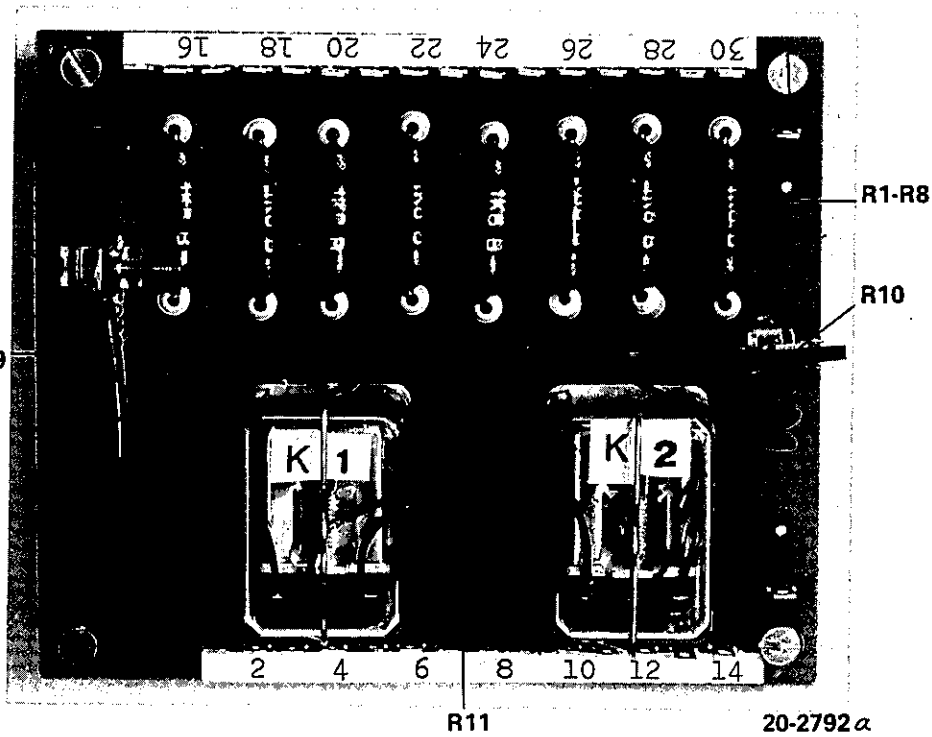
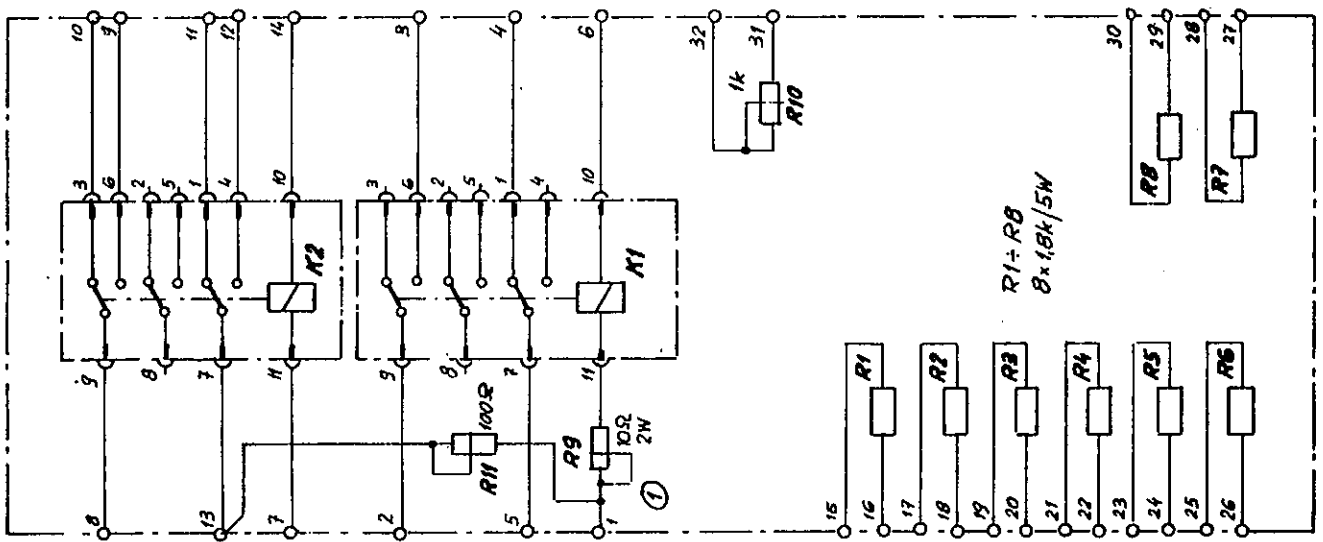

R9 für Fabr. Nr. 051-071 war 6,8 Ω, 10 W  
 R9 for Fabr. Nos. 051-071 was 6,8 Ω, 10 W

